

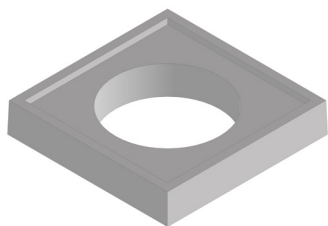

#### Dalle

Avec ou sans  
trou d'homme (TH)

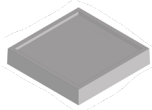

#### Réhausse

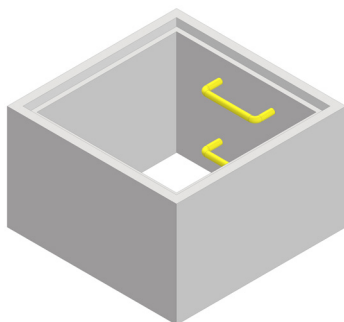

#### Fond

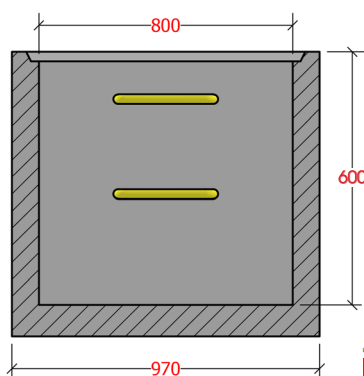
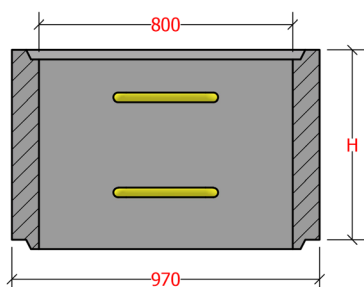
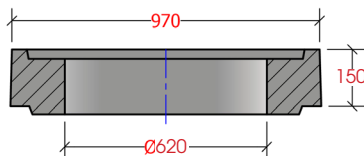
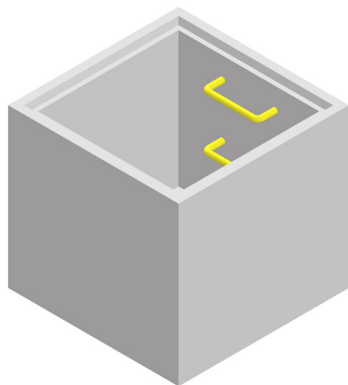

### Caractéristiques .

- Béton PM
- Manutention 2 ancres 1T3
- Avec ou sans échelons
- Carottage DN600 maximum
- Etanchéité joint impermastic mis en oeuvre sur chantier

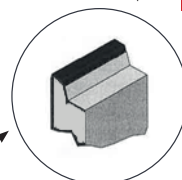

		Hauteur (mm)	Réf. Article (nu)	Réf. Article (équipé)	Poids (kg)
Réf. Article	Fond	600	FAB03669	FAB03670	600
	Réhausse (Hauteur H)	300	FAB01008	FAB01011	230
		600	FAB01009	FAB01012	460
		900	FAB01010	FAB01013	660
	Dalle réductrice (avec TH)	180	FAB00624	-	260
Dalle réductrice (sans TH)	180	FAB00625	-	300	

Fabrication usine de Chenon (16)

FT 034 version du 21/03/2024

